

LED Description

LED Status	Description/Solution
LED not on	Power issue or faulty sensor. Check power and wiring
Blinking Green	The commissioned sensor has powered up and has detected motion. If there is no motion in the sensor's field of view, the blinking will stop. Wave your hands below the sensor to restart LED blinking.
Solid Green	The un-commissioned sensor has powered up successfully and passed the wiring test – waiting for discovery.
Blinking Red	The un-commissioned sensor has powered up and detected a wiring test issue. Check the wiring.
Solid Red	Faulty sensor – replace the sensor.
Solid Blue	Sensor received a request to identify itself.
Blinking Blue	The un-commissioned sensor was not able to detect an energy measurement device (Control Unit or Driver).

Model No:

SU-5S-2W-HRW: Ruggedized Sensor, 2-wire, High Bay, White

SU-5S-2W-LRW: Ruggedized Sensor, 2-wire, Standard, White

Product Code: SU-5S-2W-xRx-xxx

xRx: HRW, LRW

xxx: IoT Node (IoT), Connected Lighting (CL),

Independent Lighting/Enlighted One (IL), Fixtureless (FL)

FCC ID: AQQ-SU5S

IC: 10138A-SU5S



A Siemens Company

FCC and Industry Canada Compliance Information

This equipment has been tested and found to comply with the limits for a Class A digital device, pursuant to part 15 of the FCC Rules.

These limits are designed to provide reasonable protection against harmful interference when the equipment is operated in a commercial environment. This equipment generates, uses, and can radiate radio frequency energy and, if not installed and used in accordance with the instruction manual, may cause harmful interference to radio communications. Operation of this equipment in a residential area is likely to cause harmful interference in which case the user will be required to correct the interference at his own expense.

This device complies with Part 15 of the FCC Rules and Industry Canada license-exempt RSS standard(s). Operation is subject to the following two conditions:

- this device may not cause harmful interference, AND
- this device must accept any interference received, including interference that may cause undesired operation.

Changes or modifications not expressly approved by Enlighted Inc. could void the user's authority to operate the equipment.

Le présent appareil est conforme aux CNR d'Industrie Canada applicables aux appareils radio exempts de licence. L'exploitation est autorisée aux deux conditions suivantes:

- l'appareil ne doit pas produire de brouillage, ET
- l'utilisateur de l'appareil doit accepter tout brouillage radioélectrique subi, même si le brouillage est susceptible d'en compromettre le fonctionnement.

CE

This device complies with the essential requirements and other relevant requirements of the R&TTE Directive (1999/5/EC) and Radio Equipment Directive (RED) 2014/53/EU. The equipment is Class 1 radio equipment which can be placed on the market and be put into service without restrictions in accordance with article 1(3) of Commission Decision 2000/299/EC (Version July 2014).

Wireless protocol: IEEE802.15.4, Radio Freq: 2400 – 2483.5MHz, RF TX output power (max): 4dBm

Wireless protocol: IEEE802.15.1, Radio Freq: 2400 – 2483.5MHz, RF TX output power (max): 4dBm

Company Contact Information

Address: : 3979 Freedom Circle, #210, Santa Clara, CA 95054

Phone: +1.650.964.1094

Web: enlightedinc.com

DoCs: <https://www.enlightedinc.com/eu-docs/>

Technical Support: support@enlightedinc.com

Copyright © 2021 Enlighted Inc. All rights reserved.

All other brand or product names are trademarks of their respective companies or organizations.



A Siemens Company

Ruggedized Sensor, 2-wire Install Guide

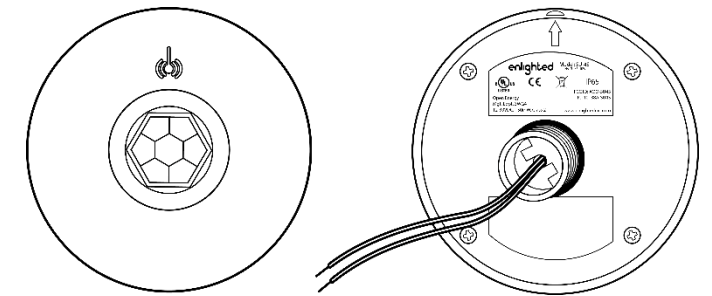

Ruggedized Sensor, 2-wire, (Front and Rear)

Shipped Components

- Ruggedized Sensor, 2-wire, (SU-5S-2W-xRx), or Fixtureless (SU-5S-2W-LRW/HRW-FL).
- ½ inch Lock Nut

Supplemental Components

- ½ inch LB Conduit Body
- ½ inch Chase Nipple

Tools you may Need

- ½ inch Knock out tool
- Wire Stripper

Caution

Installation and maintenance must be performed by a qualified electrician in accordance with local, state, and national electrical codes (NEC) and requirements.

Installation

The Ruggedized sensor, 2-wire, is shipped with the cable attached to the sensor. The sensor can be mounted to the fixture using a conduit body and chase nipple or locknut.

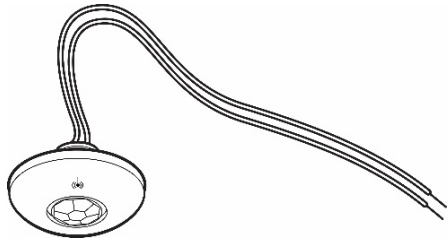

Step 1: De-energize the luminaire.

Mounting using the Conduit Body and Chase Nipple

Step 1: Remove the cover plate of the ½ inch LB conduit body by removing the two screws.

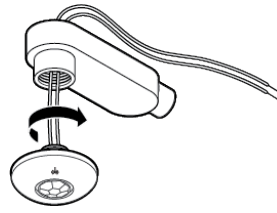
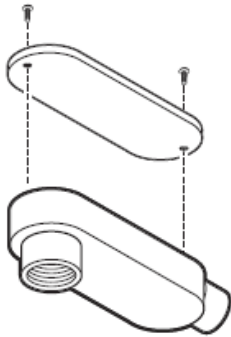

Step 2: Thread the Ruggedized sensor onto the LB conduit body.

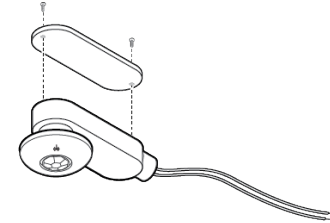

Step 3: Replace the cover and two screws on the LB conduit body.

Step 4: Knock out a ½ inch hole on the end of the light fixture.

Step 5: Mount the 2-Wire Ruggedized Sensor LB conduit to the fixture by guiding the sensor cable through the knock-out and chase nipple into the fixture.

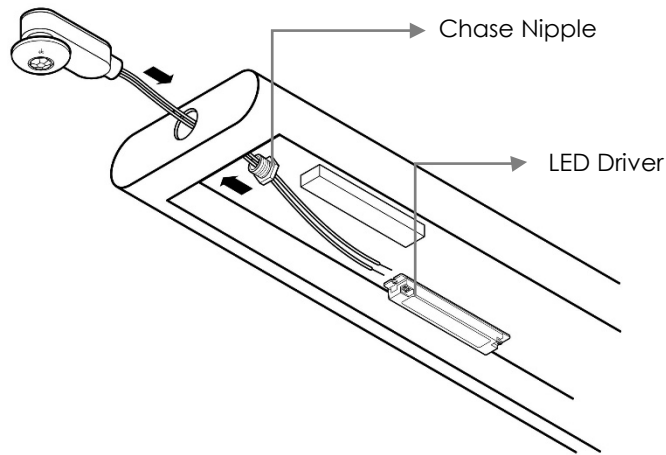

Step 6: Thread the chase nipple to securely connect the LB conduit to the fixture.

Mounting using the Locknut

Step 1: Knock out a ½ inch hole on the bottom of the light fixture.

Step 2: Glide the sensor cable through the knockout of the fixture.

Step 3: Thread the locknut tightly to secure the sensor to the fixture.

Connecting the Sensor Cable to the LED Driver

Step 1: Insert the end of the pair of wires into the LED driver.

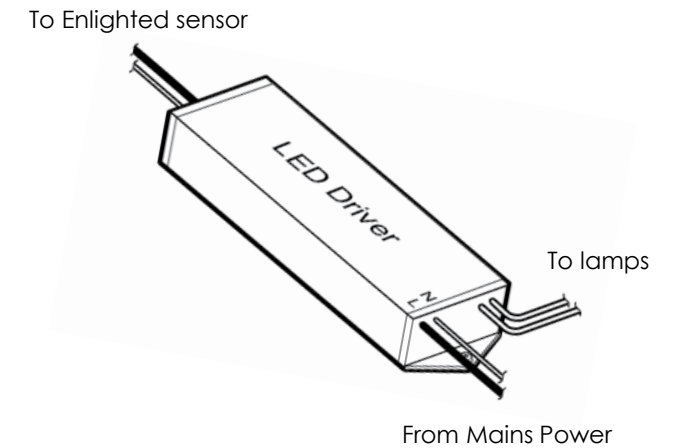

Step 2: Energize the luminaire and confirm that the green LED is on solid. Refer to the *LED Descriptions* on page 5.